

# RETOP

MAKE THE BEST ALUMINUM PROFILES

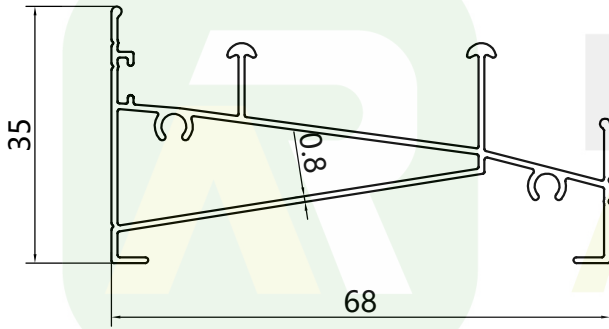

DOUBLE SILL  
Weight: 0.533kg/m

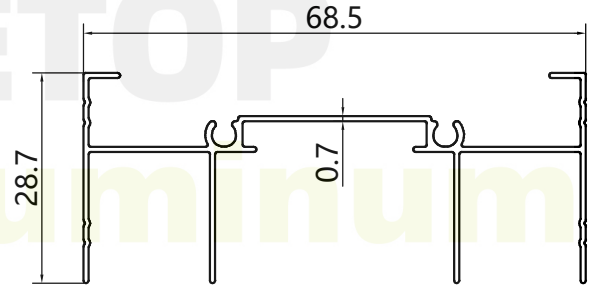

DOUBLE HEAD  
Weight: 0.378kg/m

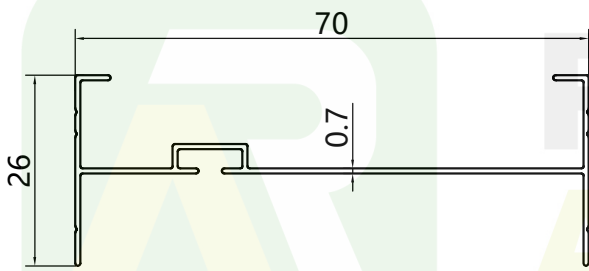

DOUBLE JAMB  
Weight: 0.269kg/m

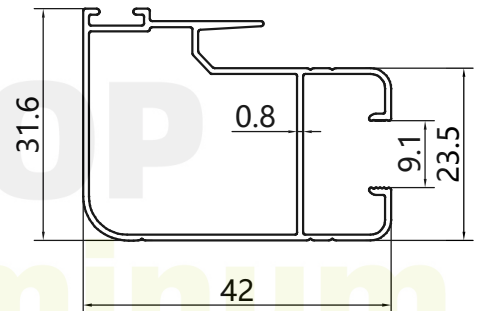

INTERLOCKER  
Weight: 0.372kg/m

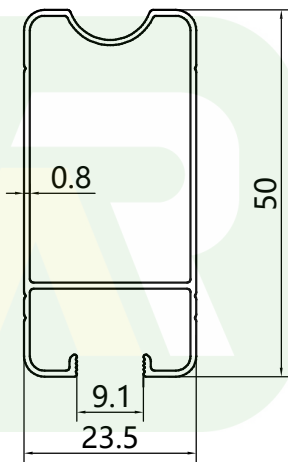

LOCKSTILE  
Weight: 0.350kg/m

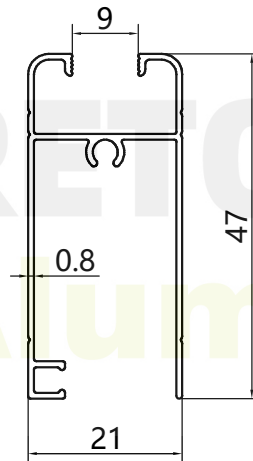

TOP/BOTTOM RAIL  
Weight: 0.315kg/m

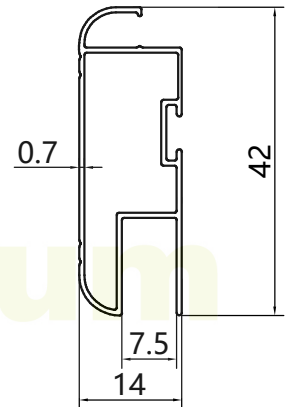

SCREEN FRAME  
Weight: 0.242kg/m

enan **RETOP** Industry Co., Ltd.  
o. 36 Dongfeng South Road, Zhengdong New District, Zhengzhou  
ity, Henan Province, P.R.China  
al/Fax: +86 371 5528 8662  
mail: sales@retop-industry.com